

850/1900MHz Dual Band Diversity RX Ceramic Antenna

Pulse Part Number CW3047A

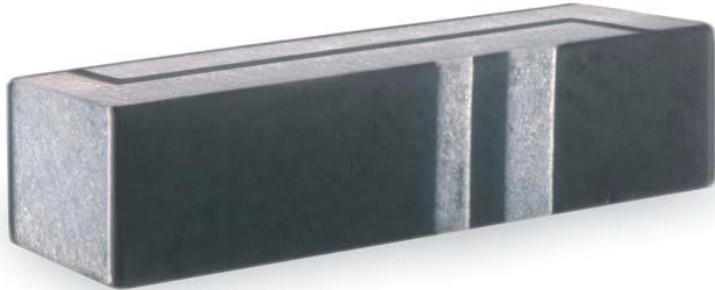

Features

- PIFA antenna
- Dual band operation, single feed point
- SMD compatible
- Lead free materials
- Size W x L x H (12 x 3 x 3 mm)
- Weight: 530 mg
- RoHS Compliant

Applications

- Dual band US GSM Rx
- 850MHz/1900MHz Rx

Electrical specifications @ +25 ° C

Note: Electrical characteristics depend on test board (GP) size and antenna positioning on GP and Ground Clearance area size.

Typical performance (testboard size 100x40 mm, PWB ground clearance area 12.8 x 6.25 mm)

Frequency Range [MHz]	Efficiency [%]/[dB]	Impedance [Ω]	Operating Temperature [$^{\circ}$ C]
869 – 894	50 / -3(peak)	50	-40 to +85
1930-1990	70 / -1.55(peak)	50	-40 to +85

850/1900MHz Dual Band Diversity RX Ceramic Antenna

Pulse Part Number CW3047A

Recommended Antenna Pad Dimensions on PWB Layout

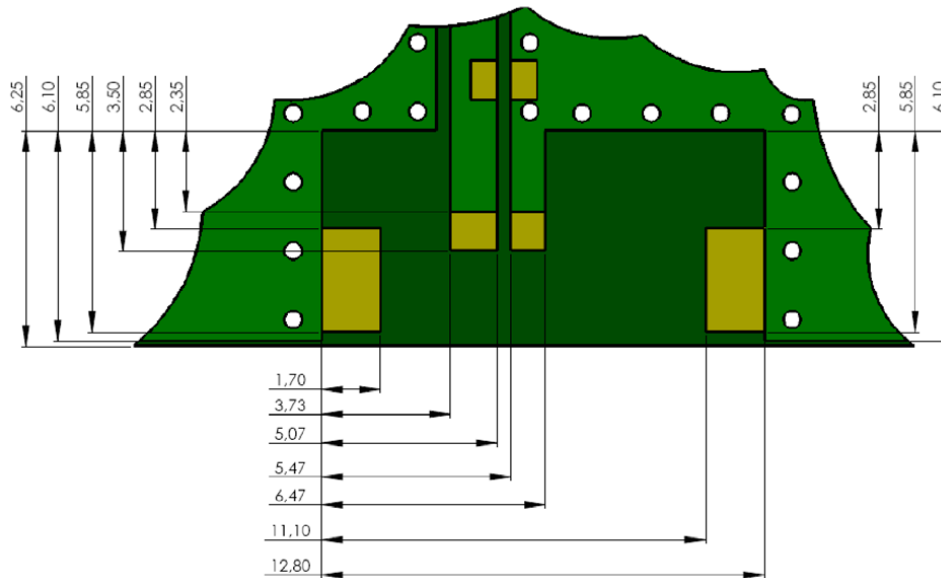
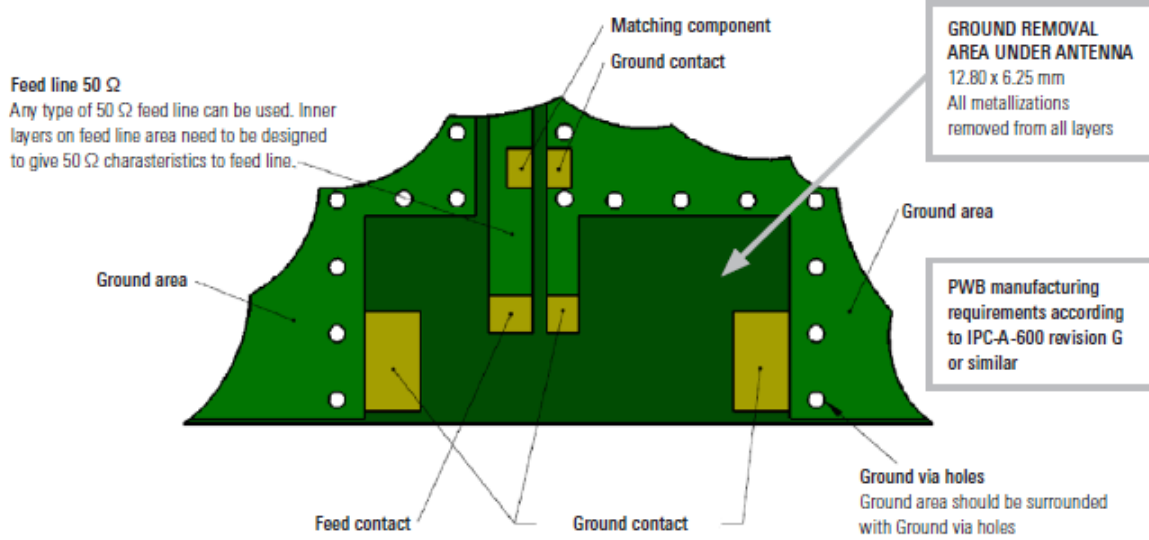

No.	Terminal Name	Terminal Dimensions
1	Feed	1.34 x 1.15 mm
2	GND	1.00 x 1.15 mm
3	GND	3.0 x 1.70 mm
4	GND	3.0 x 1.70 mm

Contact: mobiledeviceantenna.sales@pulseelectronics.com

850/1900MHz Dual Band Diversity RX Ceramic Antenna

Pulse Part Number CW3047A

Recommended ground clearance area under antenna on PWB

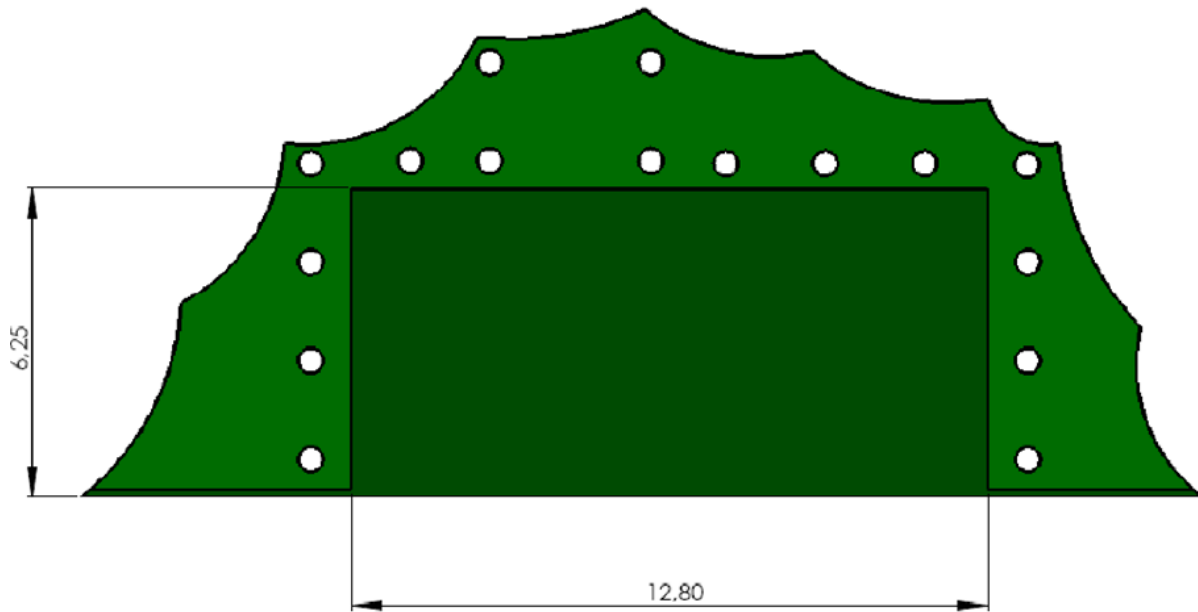

3D-view of test setup

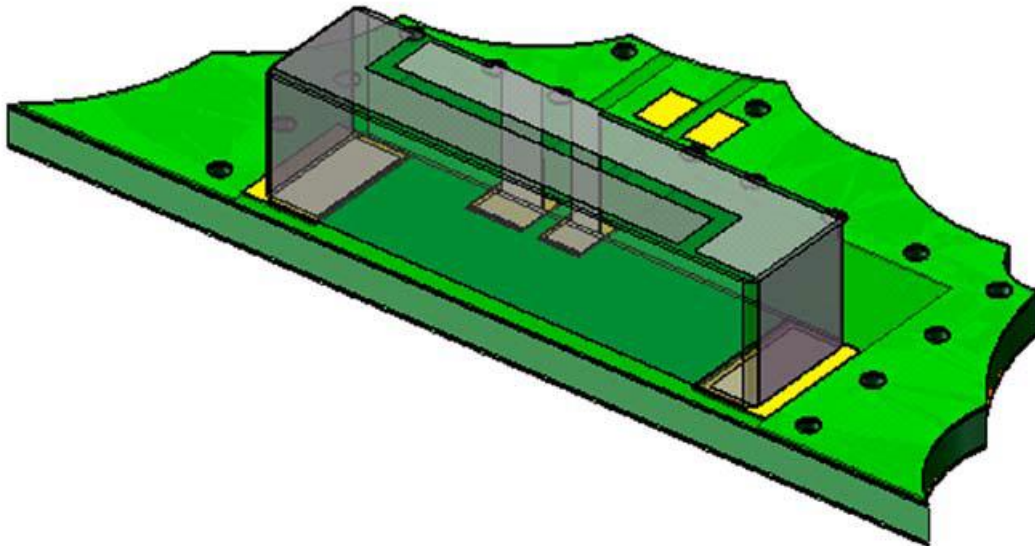

Contact: mobiledeviceantenna.sales@pulseelectronics.com

850/1900MHz Dual Band Diversity RX Ceramic Antenna

Pulse Part Number CW3047A

Typical Electrical Characteristics (T=25 ° C)

Measured on the 100x40mm test board, antenna location is side center.

Typical Return Loss and impedance

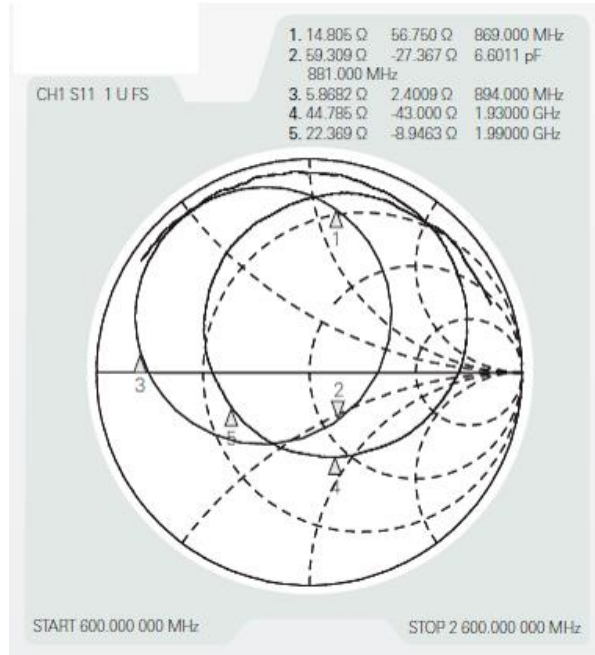
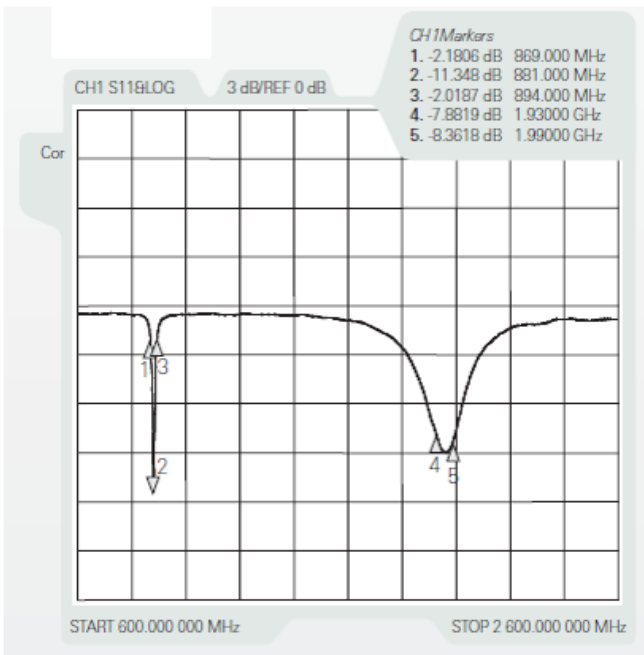

Free space efficiency and maximum gain

3D Total Efficiency

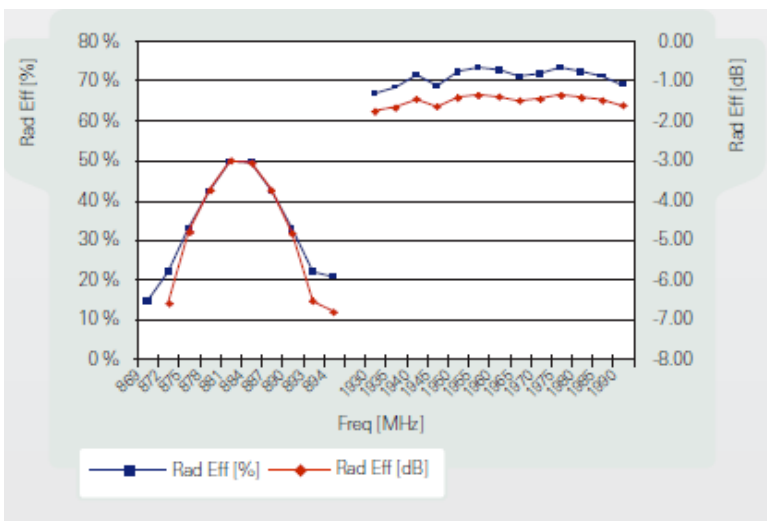

3D Max/Avg. Gain

