

1.9 GHz Diversity RX ceramic antenna

Pulse Part Number CW3038



Features

- Omni directional radiation
- Low profile
- Compact size W x L x H (3.2 x 1.6 x 1.1 mm)
- Low weight (33 mg)
- Lead free materials
- Fully SMD compatible
- Lead free soldering compatible
- Tape and reel packing
- RoHS Compliant Product

Applications

- PCS Rx
- 1.9 GHz Diversity RX

Electrical specifications @ +25 ° C

Note: Electrical characteristics depend on test board (GP) size and antenna positioning on GP and Ground Clearance area size.

Typical performance (testboard size 80x37 mm, PWB ground clearance area 4.0 x 4.25 mm)

Frequency Range [MHz]	Linear Max Gain [dBi]	Return loss min. [dB]	Efficiency [%]/[dB]	Impedance [Ω]	Operating Temperature [$^{\circ}$ C]
1930 – 1990	1.8 (peak) 0.5 (band edges)	-6	70 / -1.55(peak) 50 / -3(band edges)	50	-40 to +85

1.9 GHz Diversity RX ceramic antenna

Pulse Part Number CW3038

Terminal Configuration and antenna dimensions

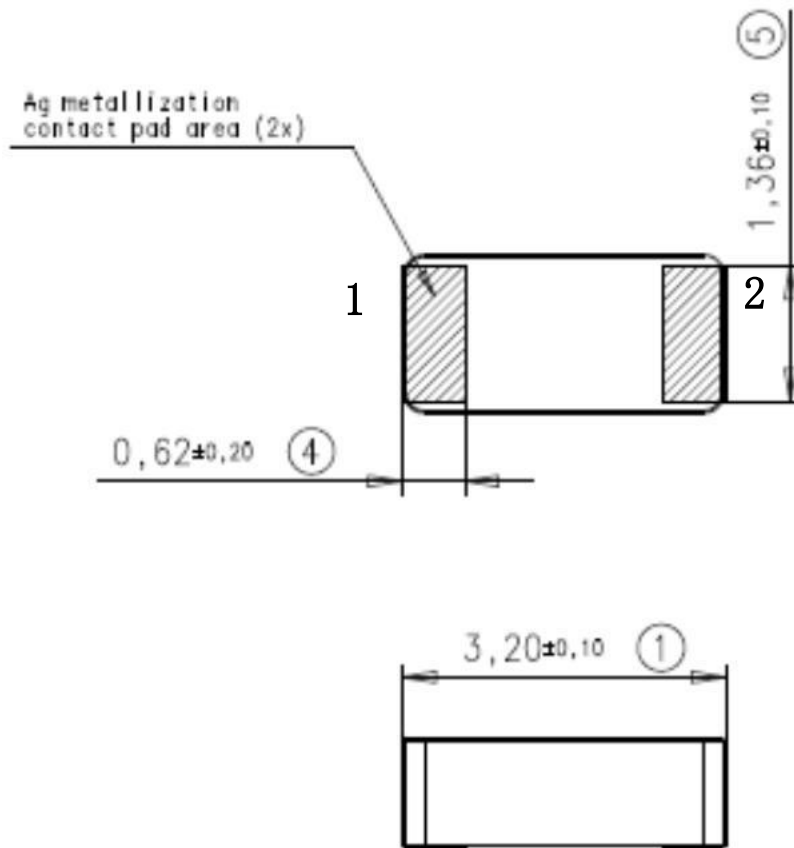

No.	Terminal Name	Terminal Dimensions
1	Feed / GND	0.62 x 1.36 mm
2	Feed / GND	0.62 x 1.36 mm
Antenna is symmetrical. Either of terminals 1 or 2 can be Feed / GND		

1.9 GHz Diversity RX ceramic antenna

Pulse Part Number CW3038

Antenna PWB Layout

Ground cleared under antenna, clearance area 4.00 x 4.25 mm, Matching and tuning component value and placement depend on application and surrounding mechanics / materials.

Feed line should be designed to match 50 Ω characteristic impedance, depending on PWB material and thickness.

Recommended test board layout for electrical characteristic measurement, test board outline size 80 x 37 mm.

Note: All dimensions are in metric system.

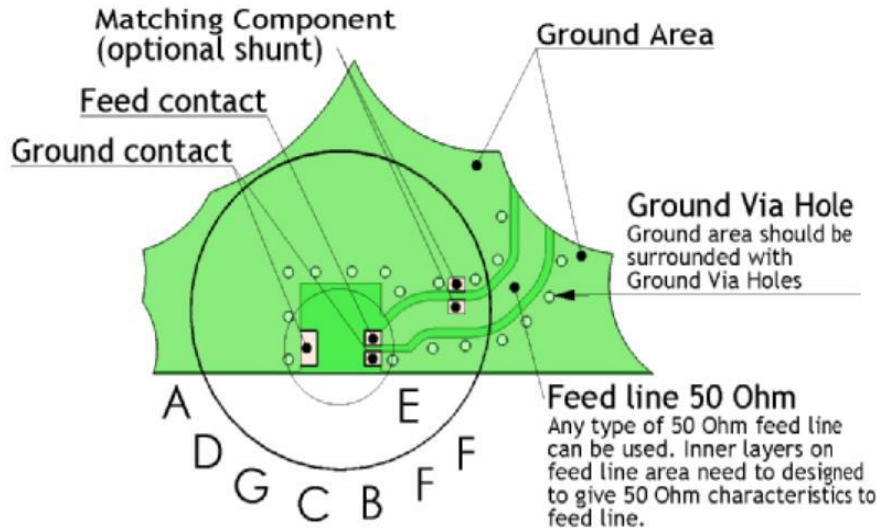

Ground clearance area

Ground clearance area (4,00 x 4,25 mm)

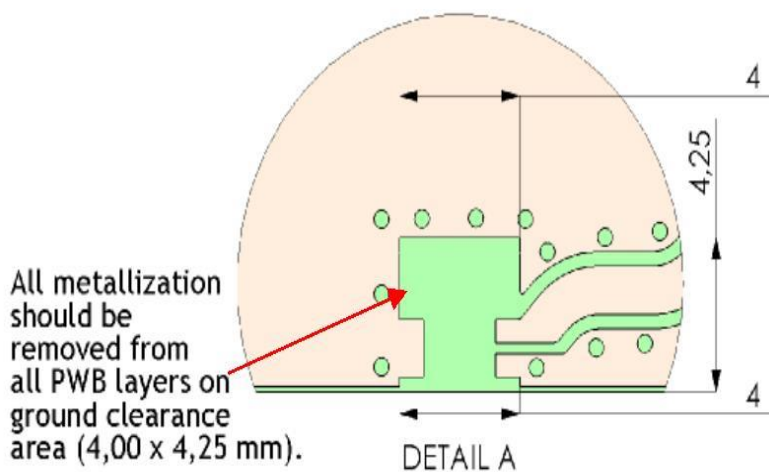

Opening in bottom/inner ground layers

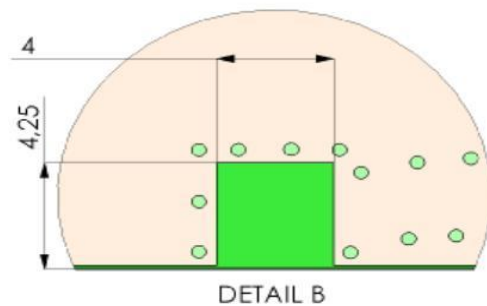

Opening in other layers (no ground/ RF)

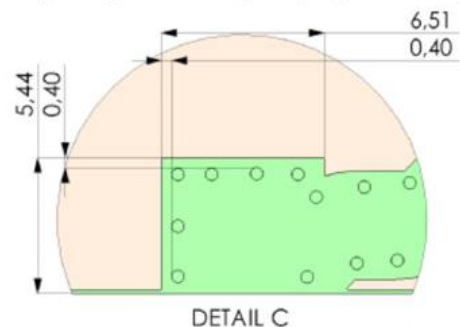

1.9 GHz Diversity RX ceramic antenna

Pulse Part Number CW3038

PWB pad dimensions and antenna position

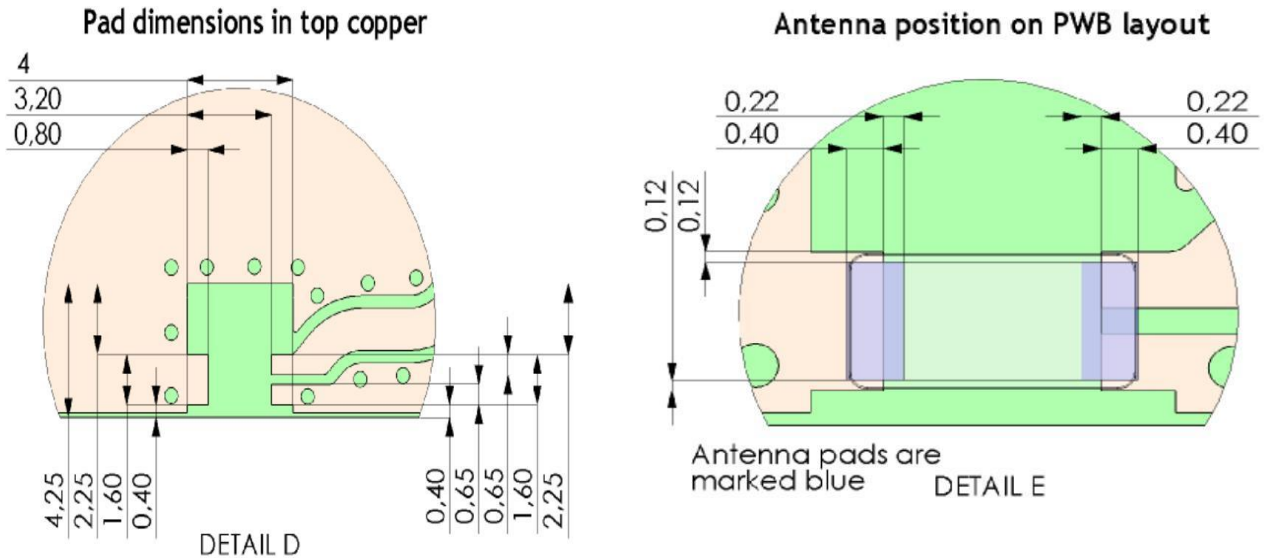

Typical Ground via hole placement in PWB layout

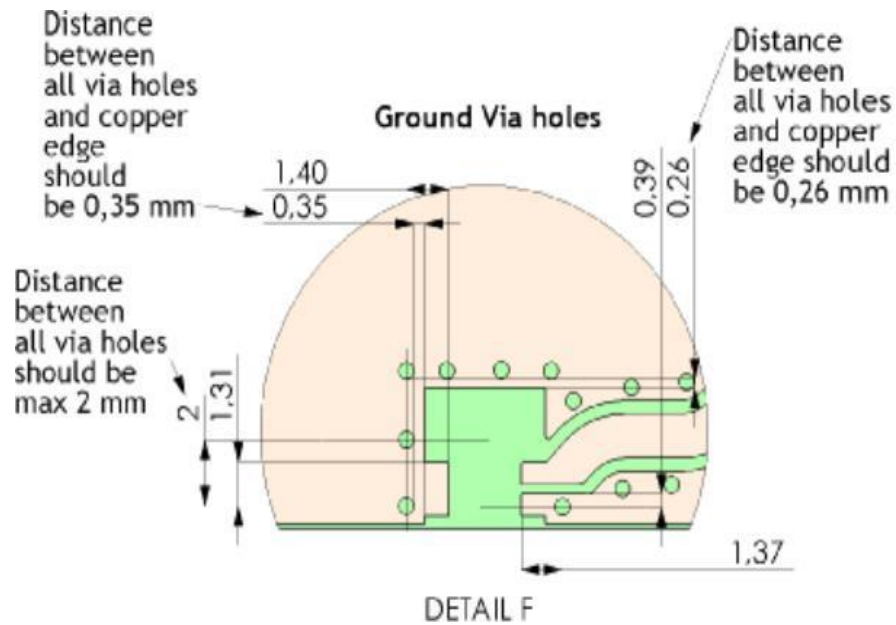

1.9 GHz Diversity RX ceramic antenna

Pulse Part Number CW3038

Solder resist opening and paste stencil recommendations

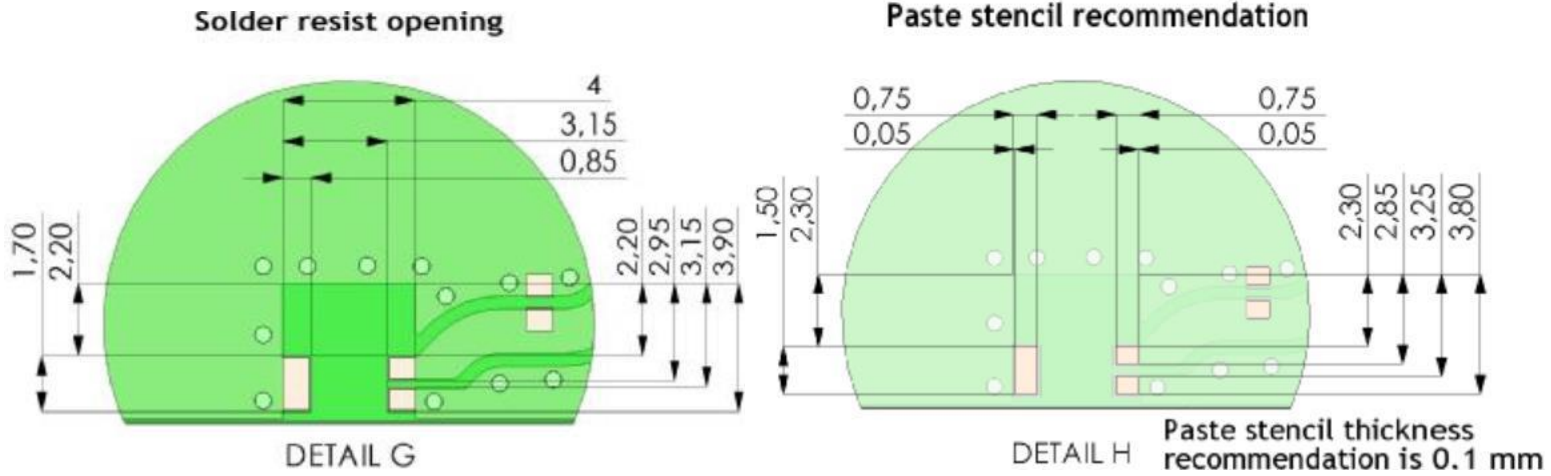

Recommended antenna position on PWB

Our test PWB size is 37 x 80 mm, other sized boards can be used depending on customer device size (minimum 35 x 35 mm)

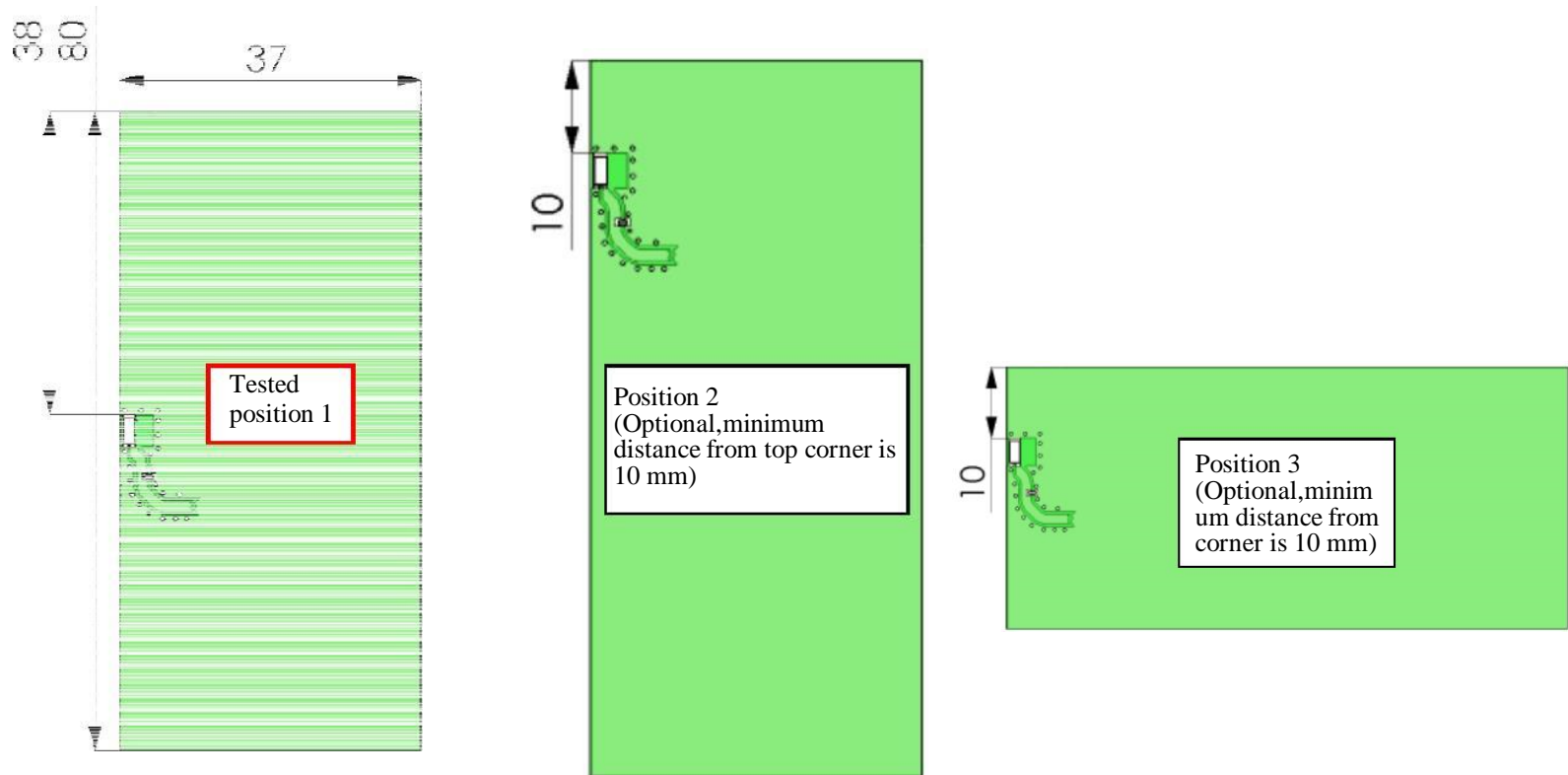

Contact: mobiledeviceantenna.sales@pulseelectronics.com

1.9 GHz Diversity RX ceramic antenna

Pulse Part Number CW3038

Typical Electrical Characteristics (T=25 °C)

Measured on the 80 x 37mm test board without matching circuit

Typical Return Loss S11/ impedance

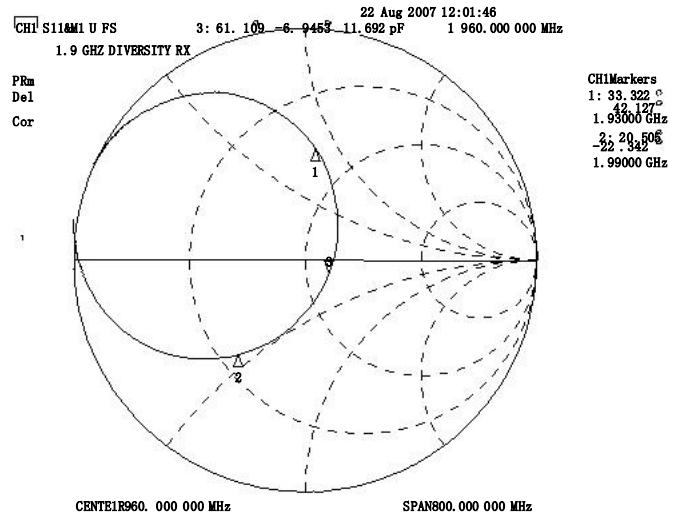
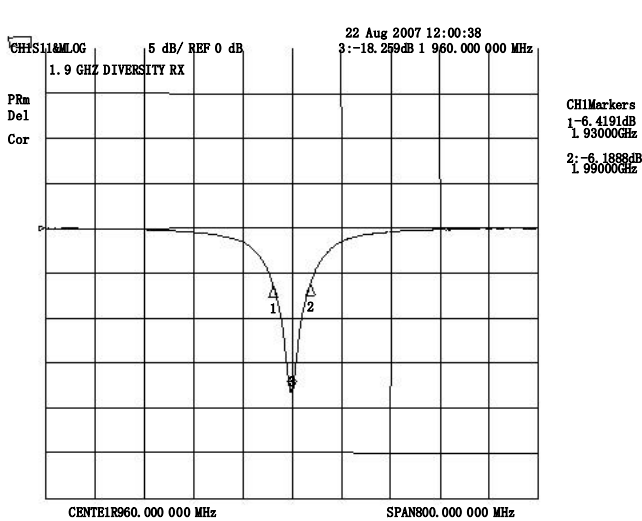

Typical free space efficiency and maximum gain

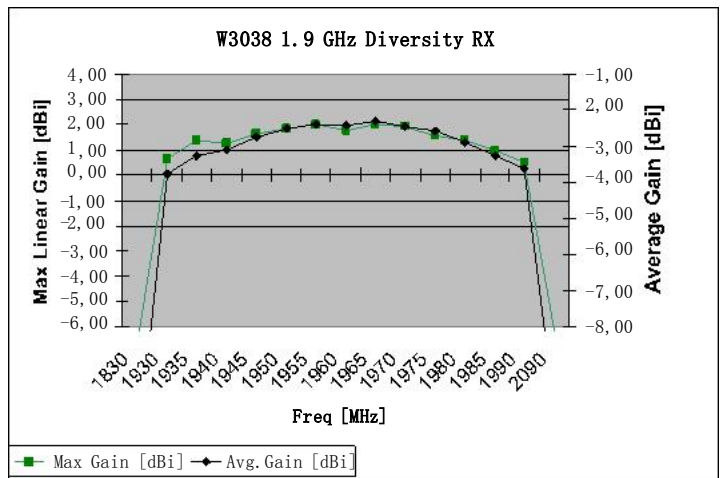
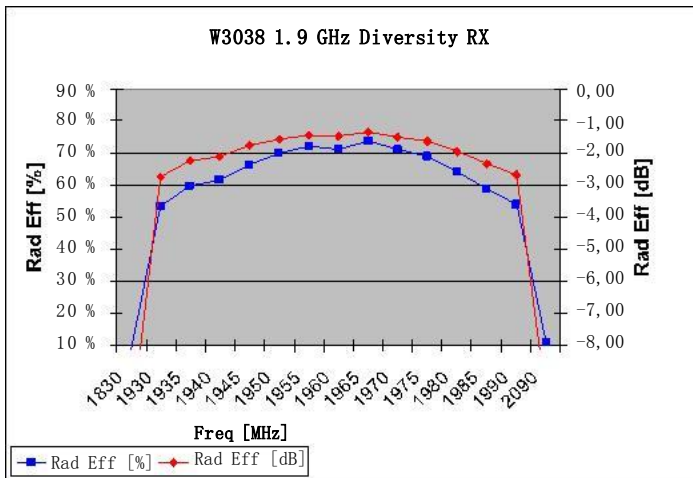

Contact: mobiledeviceantenna.sales@pulseelectronics.com



1.9 GHz Diversity RX ceramic antenna

Pulse Part Number CW3038

Typical Free Space Radiation Patterns

XZ-PLAN

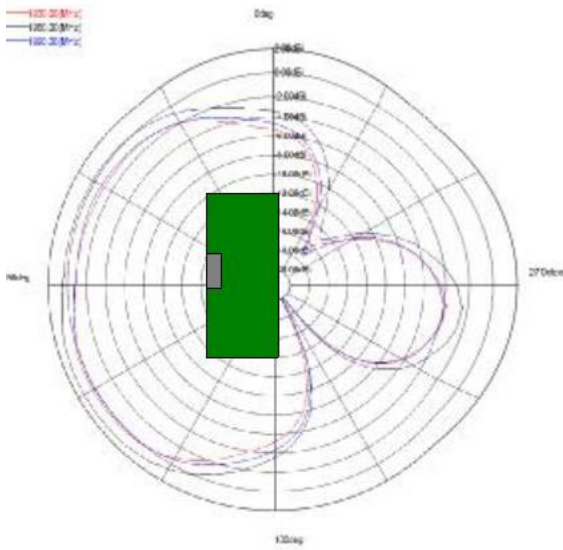

ZY-PLANE

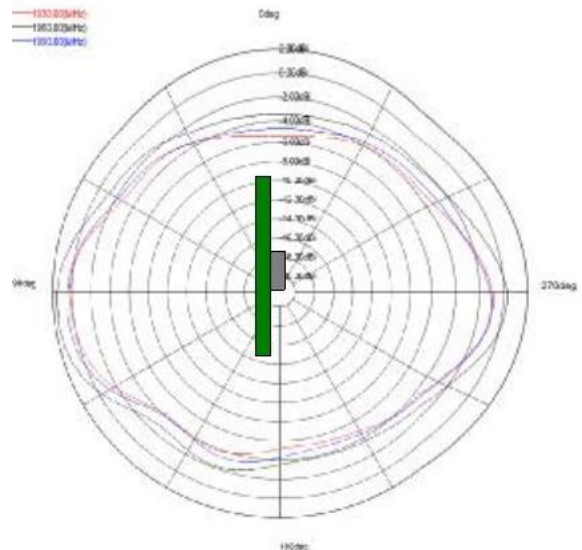

XY-PLANE

